

ACDS.8 ArtiosCAD Designer Solution

Folding Carton

1,Artios CAD Folding Carton

	資料NO.	ファイル名
Corrugated		
1,Artios CAD Corrugated	ACDS.1	Artios CAD Corrugated & Trays
2,FEFCO		
FEFCO 200series	ACDS.2	FEFCO 200series
FEFCO 300series	ACDS.3	FEFCO 300series
FEFCO 400series	ACDS.4	FEFCO 400series
FEFCO 500series	ACDS.5	FEFCO 500,600series
FEFCO 600series	ACDS.6	FEFCO 700,900series
FEFCO 700series	ACDS.6	FEFCO 700,900series
FEFCO 900series	ACDS.6	FEFCO 700,900series
2b,FEFCO(nur metrisch)	ACDS.7	FEFCO nur metrisch200,400,700serie
Folding Carton		
1,ArtiosCAD Folding Carton	ACDS.8	ArtiosCAD foldingCarton
2,ECMA	ACDS.9	foldingCarton2,ECMA



Printer

UJF-6042

UV PRINTER



Cutting plotter

CFL-605RT



Ink

LH-100



Media

Coated card board 230g



Laminating film

PP Hot Laminating film
9327KA × 500 25μ



A,sleves

ACDS.8-1

File name

Standard Sleeve

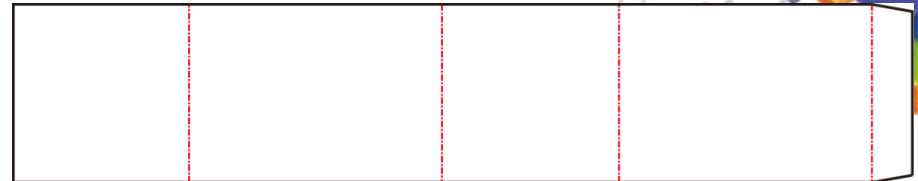
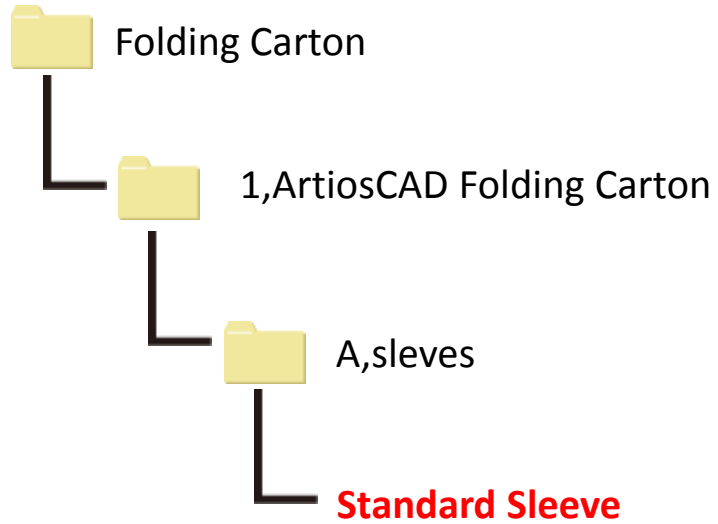

2,Unituck slit lock bottom

ACDS.8-2

File name

RT top tuck on 2nd

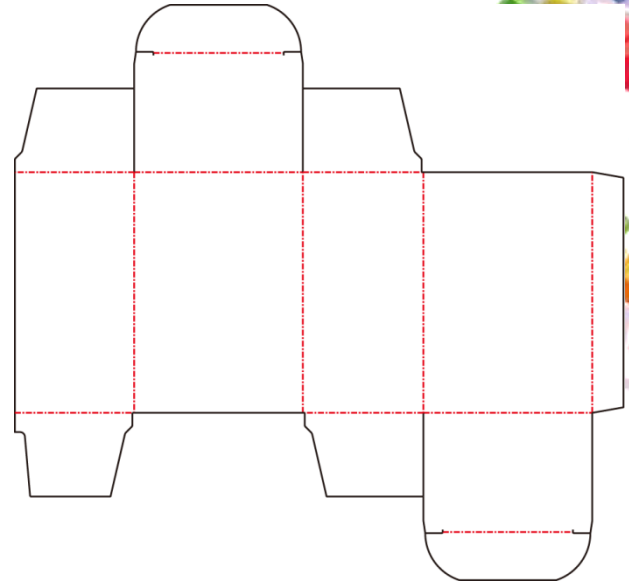
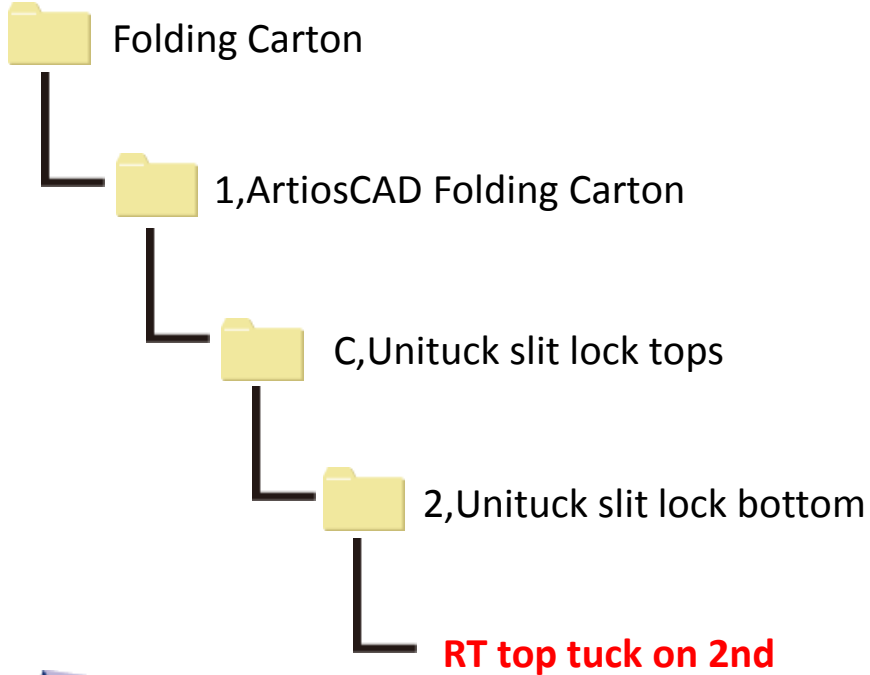

2,Unituck slit lock bottom

ACDS.8-3

File name

RT top tuck on 4th

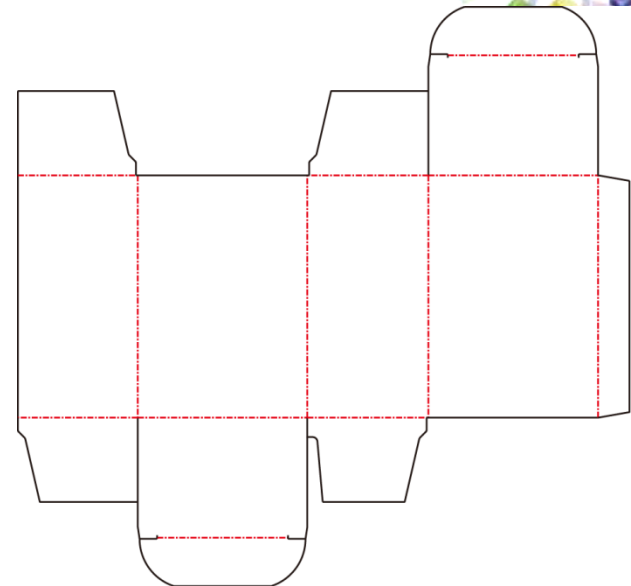
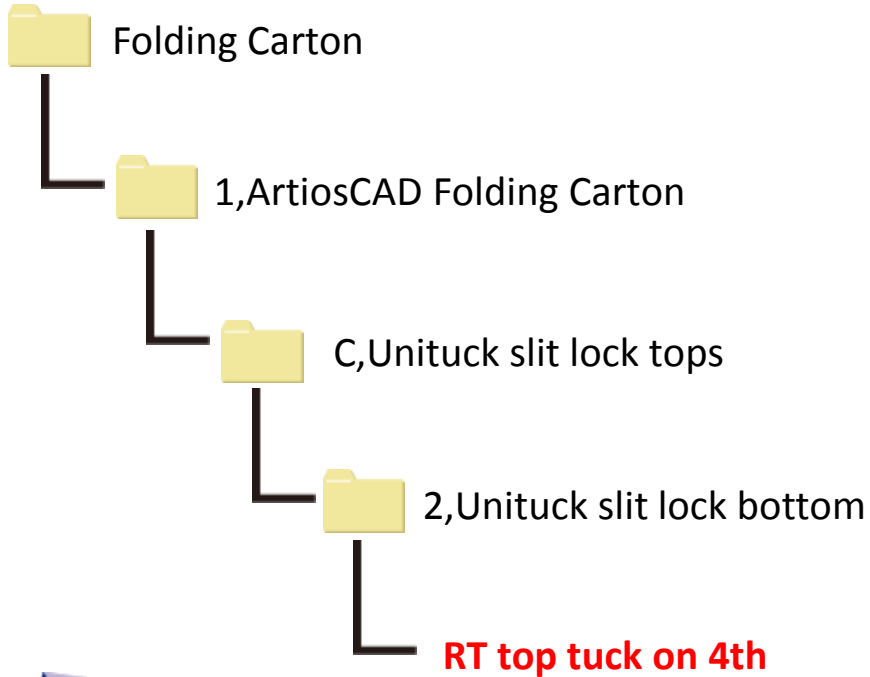

2,Unituck slit lock bottom

ACDS.8-4

File name

ST top tuck on 2nd

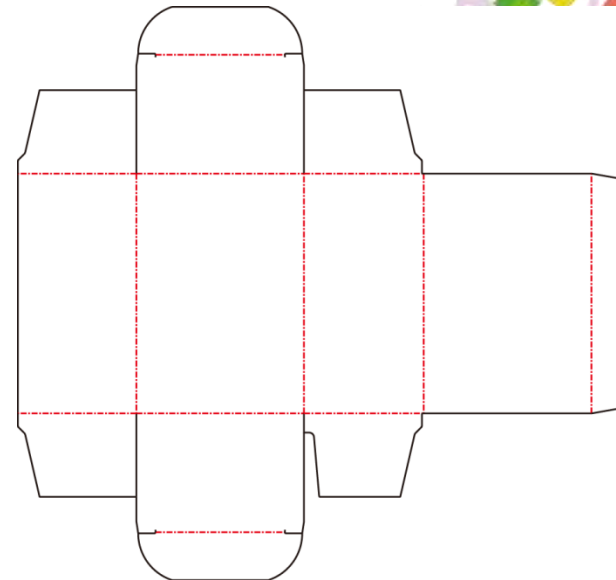
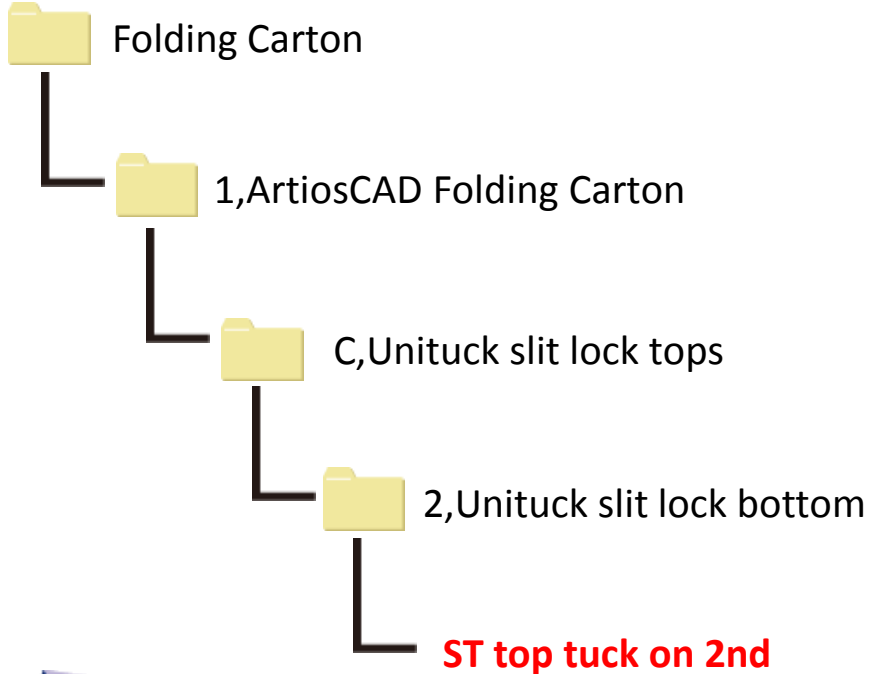

2,Unituck slit lock bottom

ACDS.8-5

File name

ST top tuck on 4th

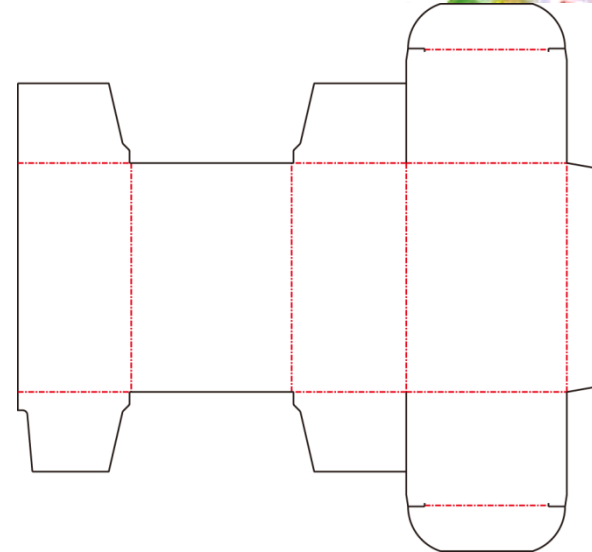
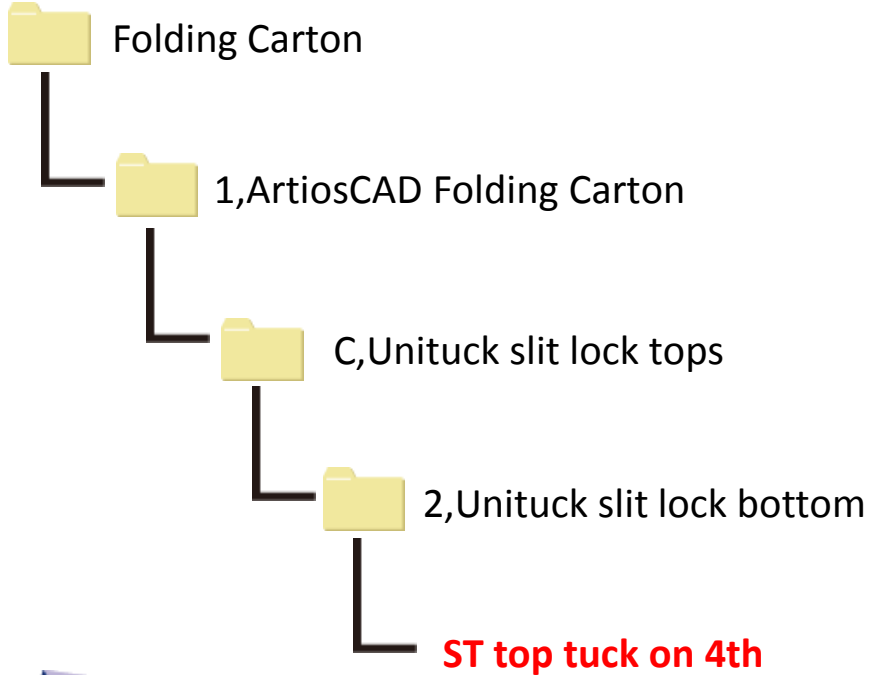

MIMAKI

4,Hougkland bottom

ACDS.8-6

File name

Tuck on 2nd tab on 2nd

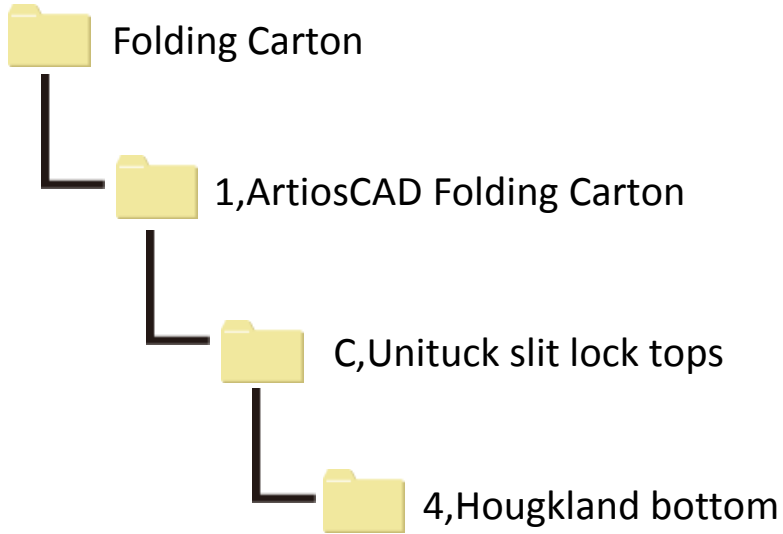

Tuck on 2nd tab on 2nd

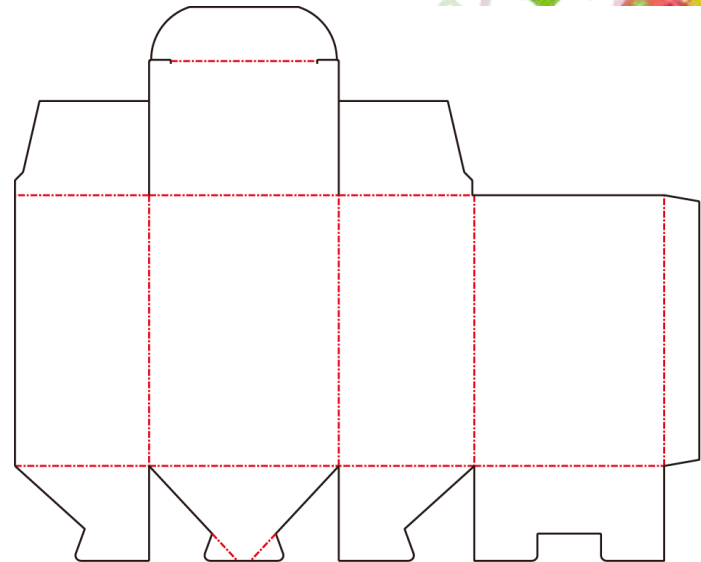

4,Hougkland bottom

ACDS.8-7

File name

Tuck on 2nd tab on 4th

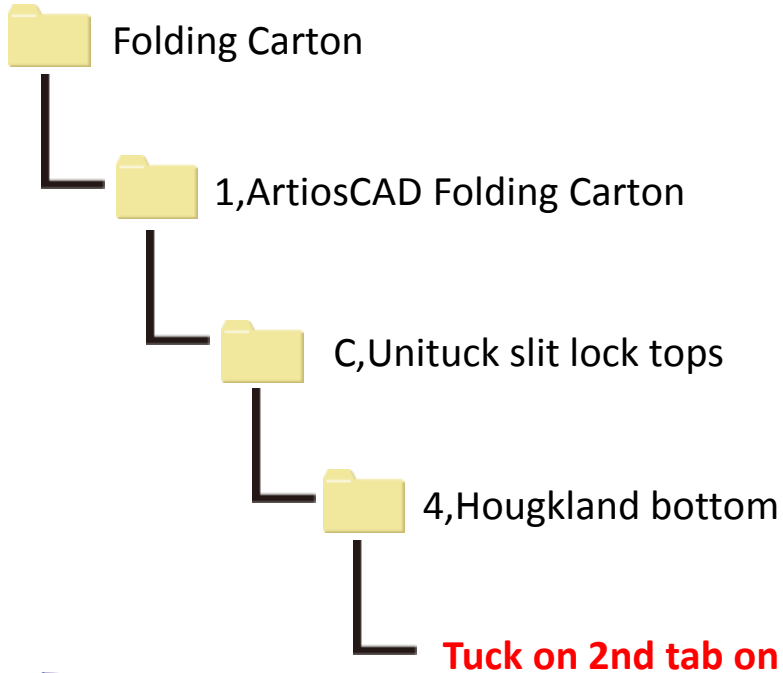

Tuck on 2nd tab on 4th

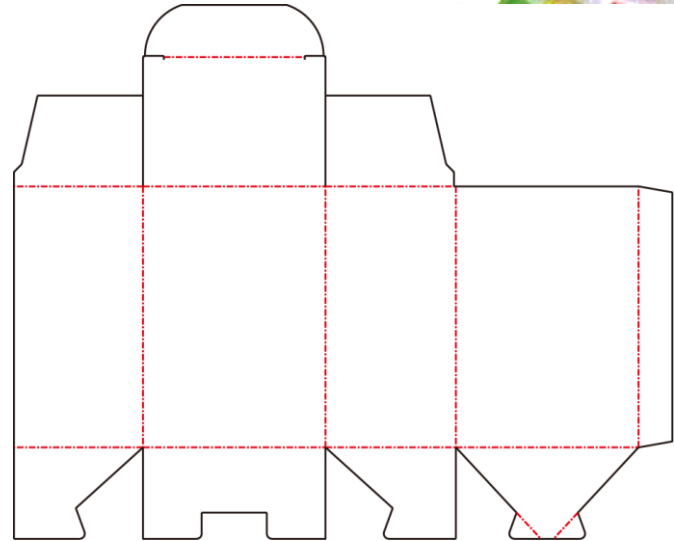

4,Hougkland bottom

ACDS.8-8

File name

Tuck on 4th tab on 2nd

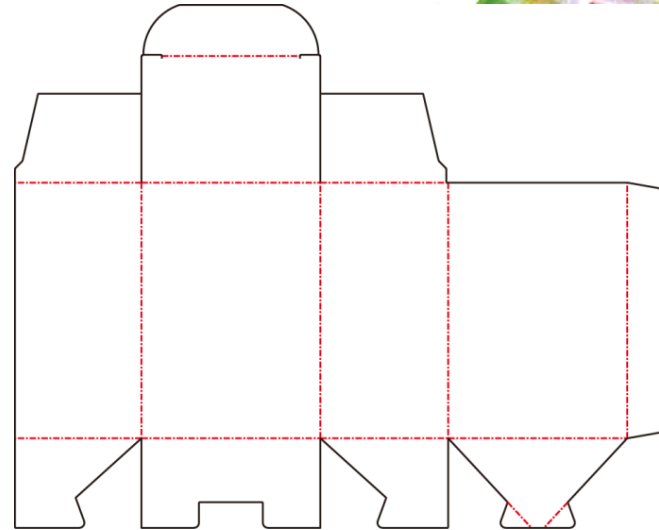
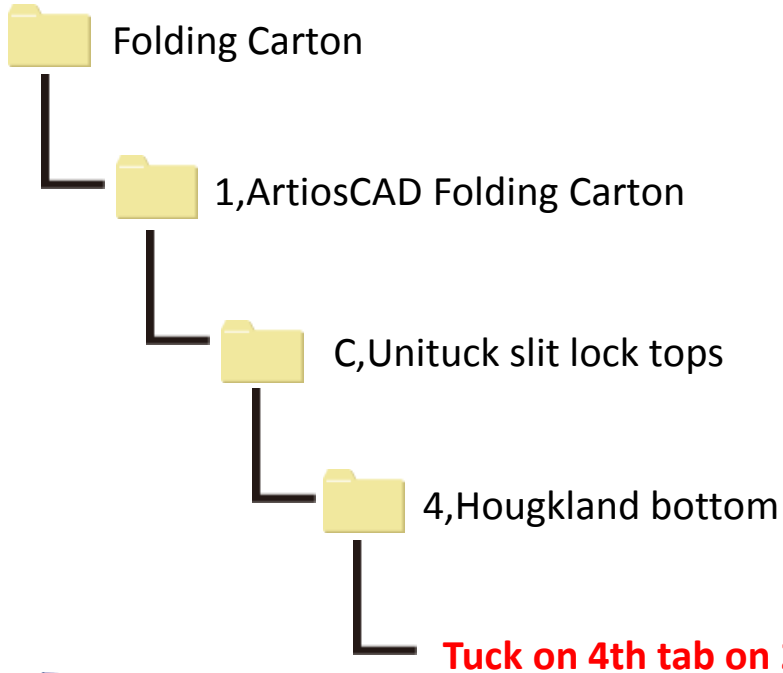

4,Hougkland bottom

ACDS.8-9

File name

Tuck on 4th tab on 4th

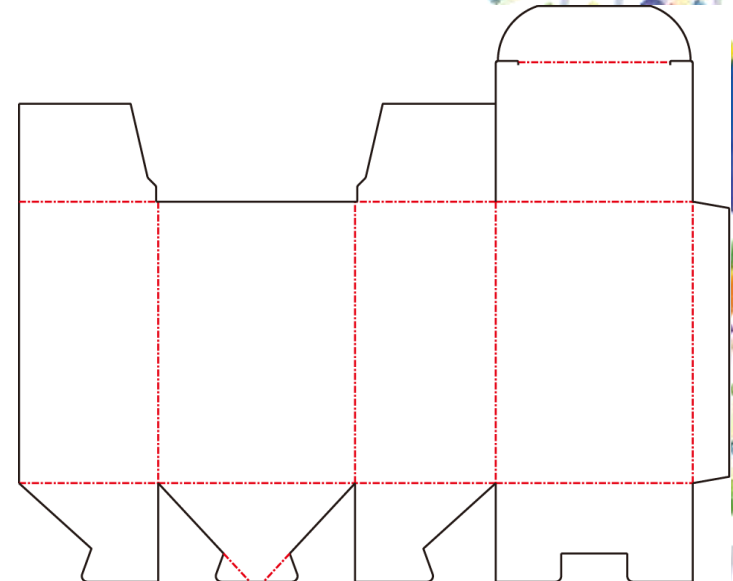
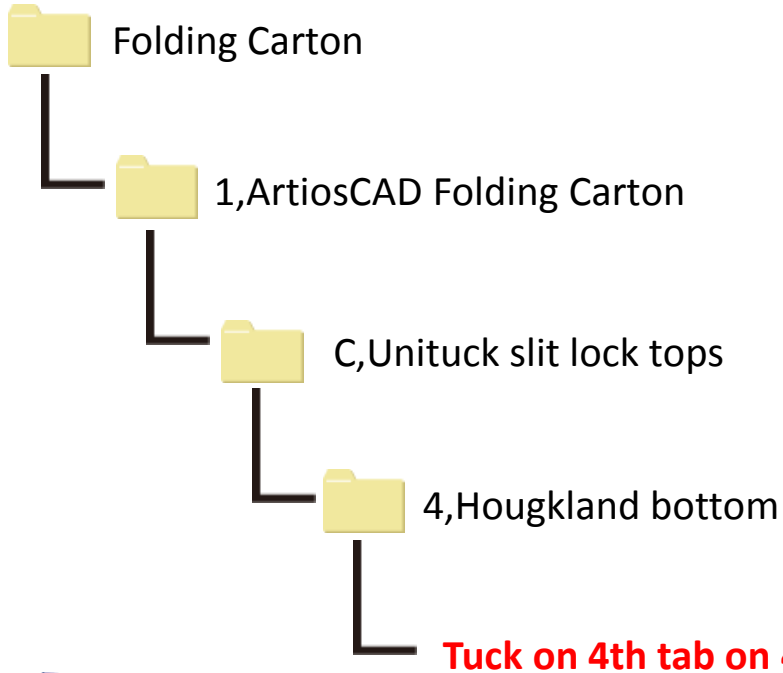

6,Inturn auto bottom

ACDS.8-10

File name

Tuck top on 2nd

Folding Carton

1,ArtiosCAD Folding Carton

C,Unituck slit lock tops

6,Inturn auto bottom

Tuck top on 2nd

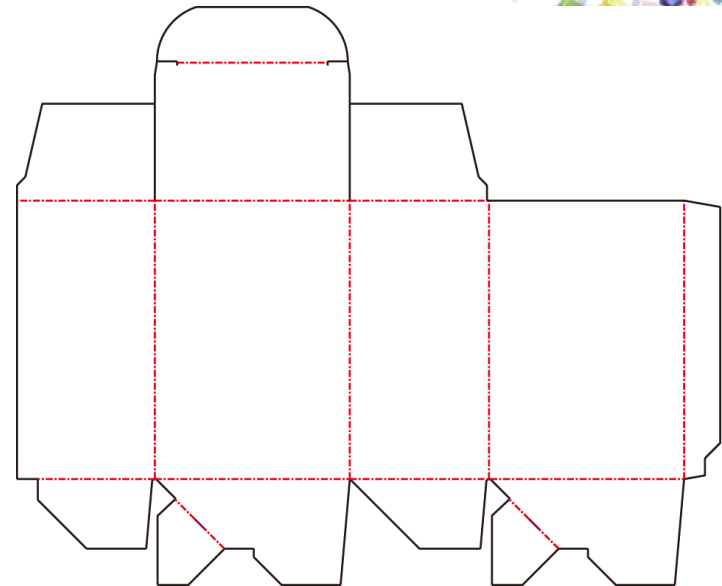

6,Inturn auto bottom

ACDS.8-11

File name

Tuck top on 4th

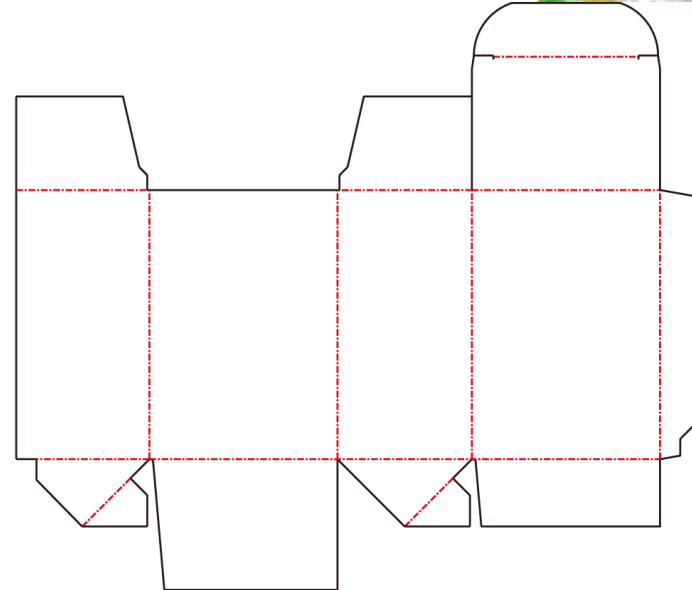
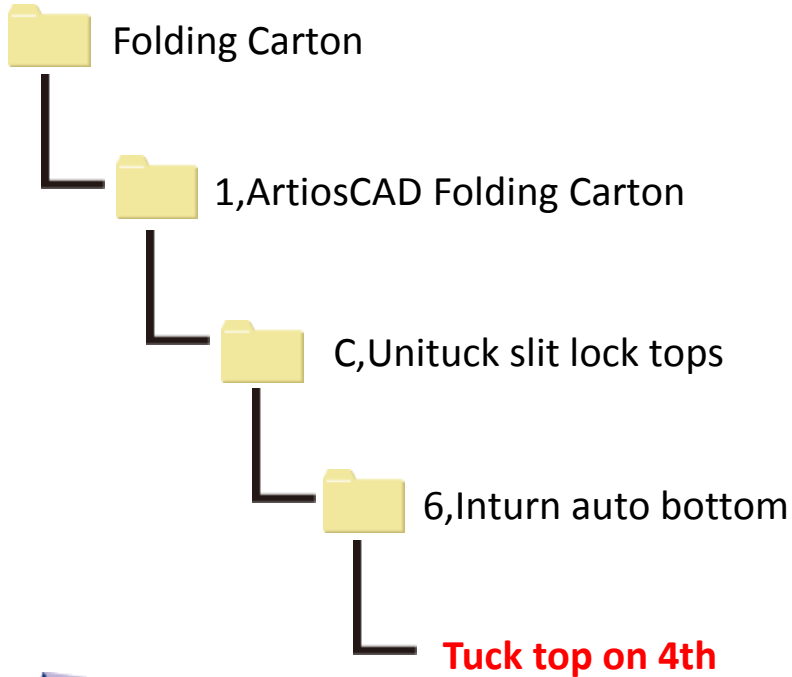

6,Inturn auto bottom

ACDS.8-12

File name

Flap style #1

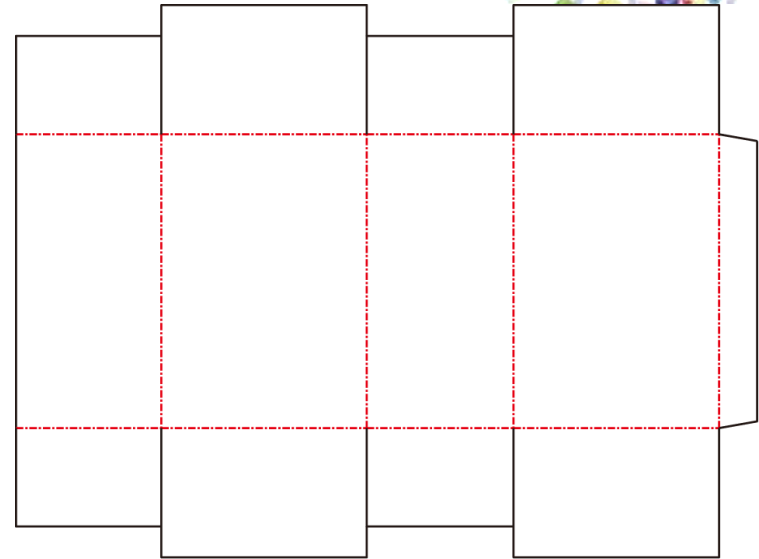
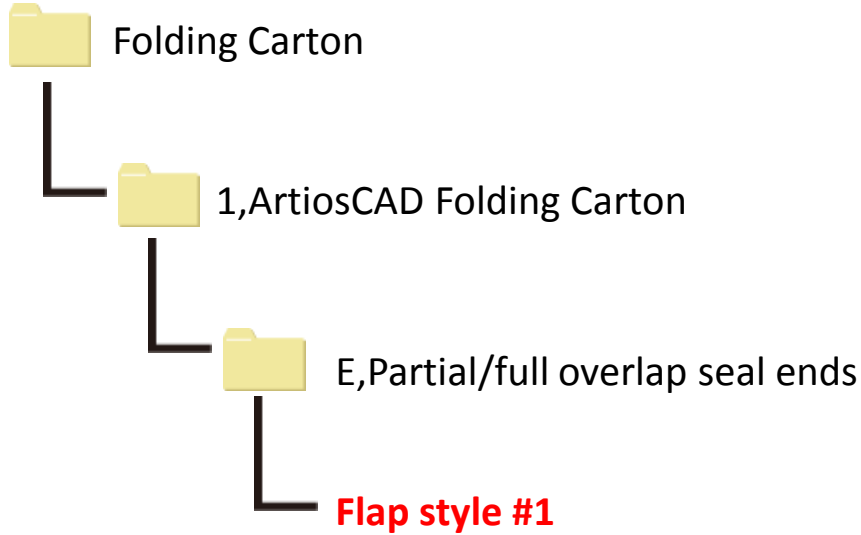

Mimaki™

6,Inturn auto bottom

ACDS.8-13

File name

Flap style #2

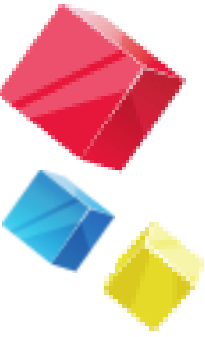

Folding Carton

1,ArtiosCAD Folding Carton

E,Partial/full overlap seal ends

Flap style #2

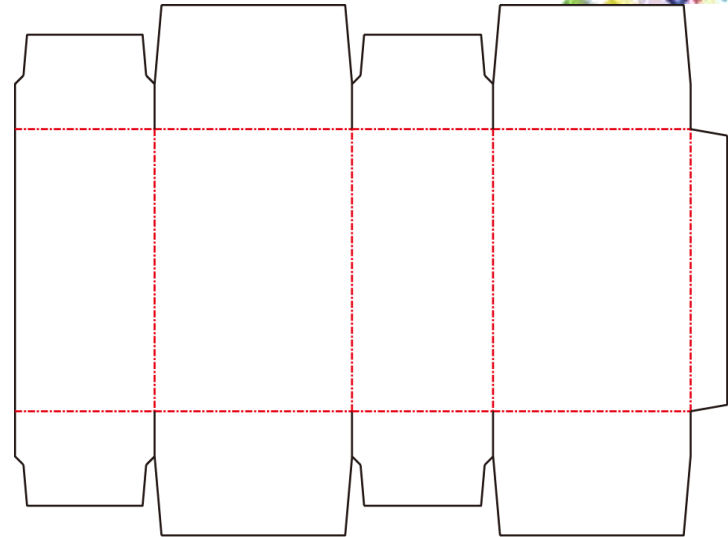

Mimaki™

6,Inturn auto bottom

ACDS.8-14

File name

Flap style #3

Folding Carton

1,ArtiosCAD Folding Carton

E,Partial/full overlap seal ends

Flap style #3

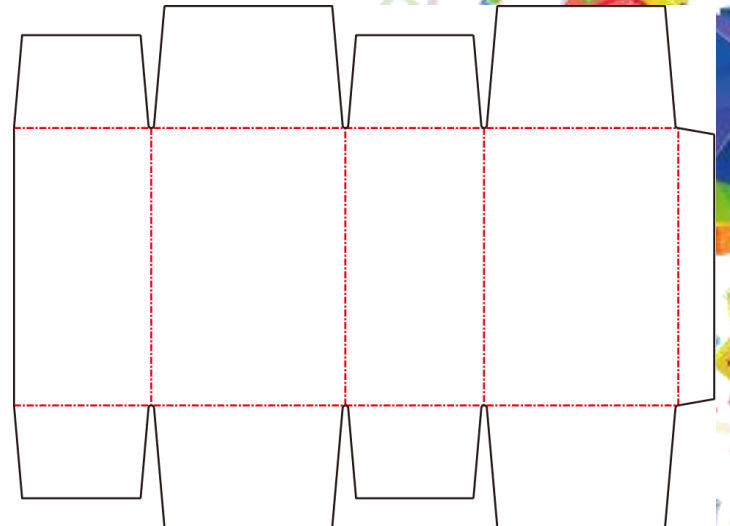

6,Inturn auto bottom

ACDS.8-15

File name

Flap style #4

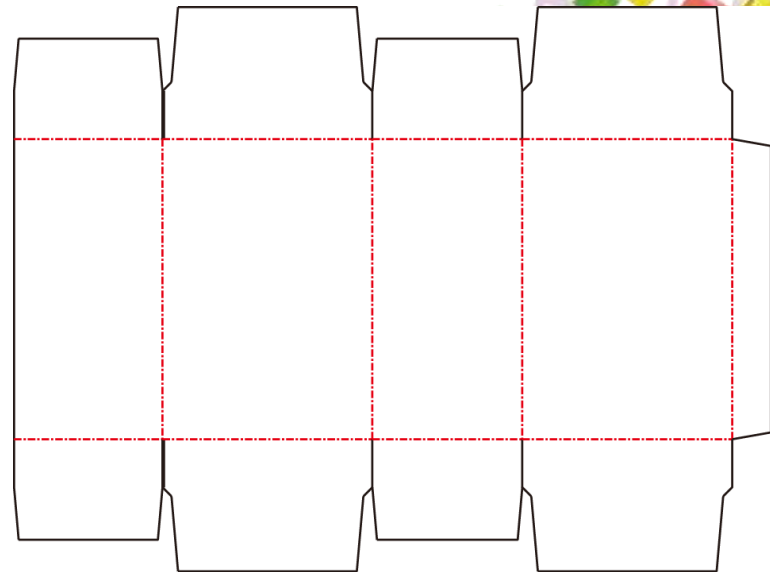
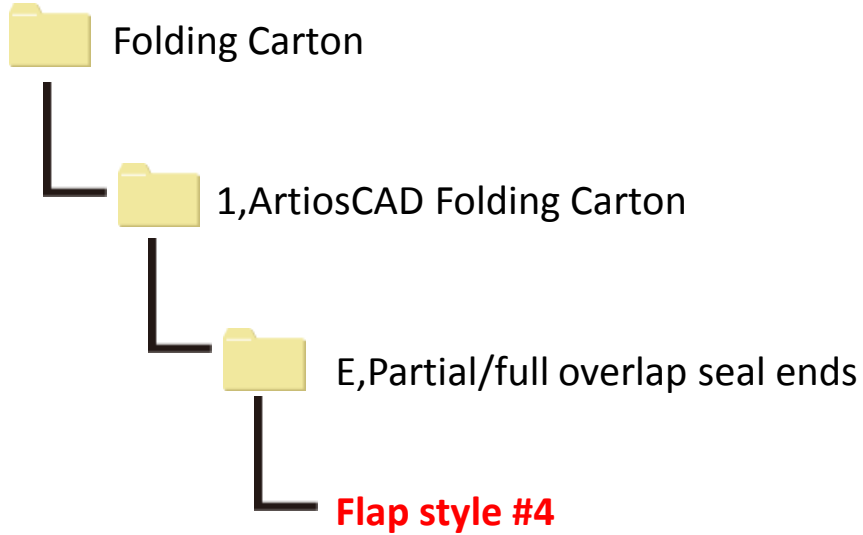

Mimaki™

Bees

ACDS.8-16

File name

Standard fulldrag

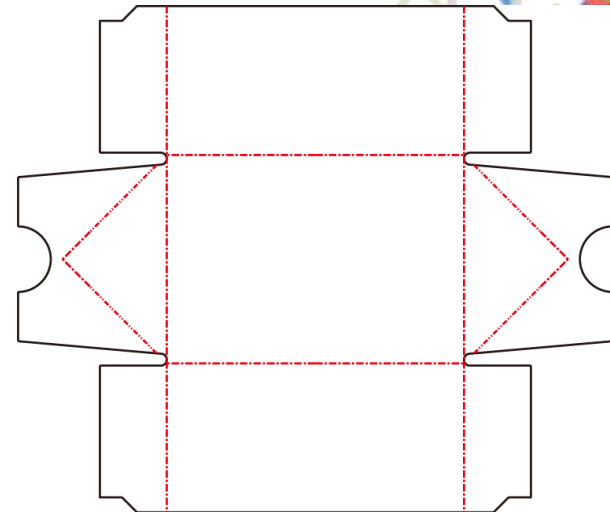
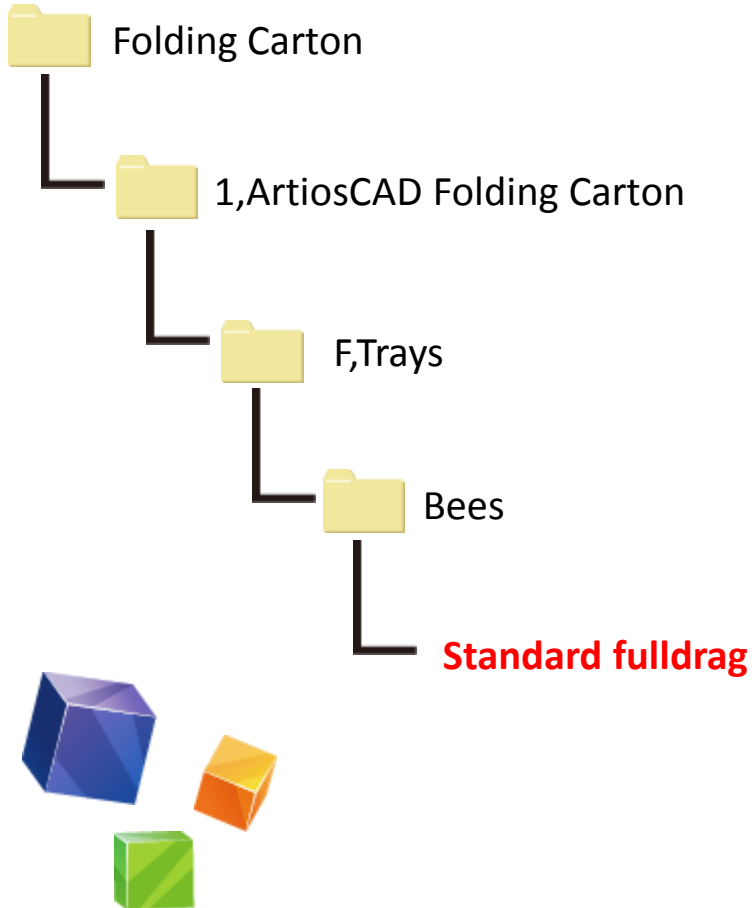

Mimaki™

Infold /

ACDS.8-17

File name

Infold / outfold

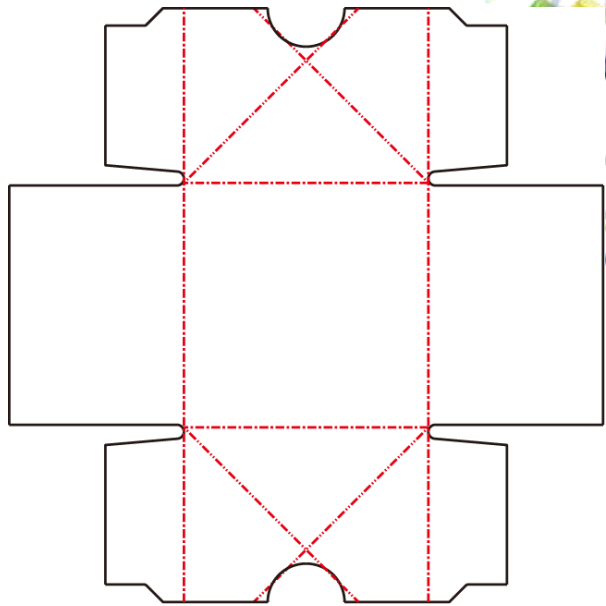
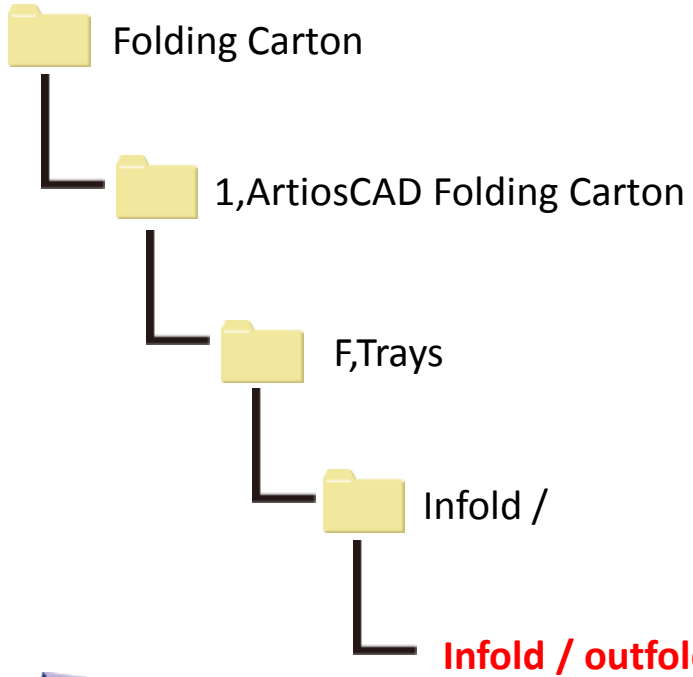

Walker lock

ACDS.8-18

Mimaki™

File name

Walker lock

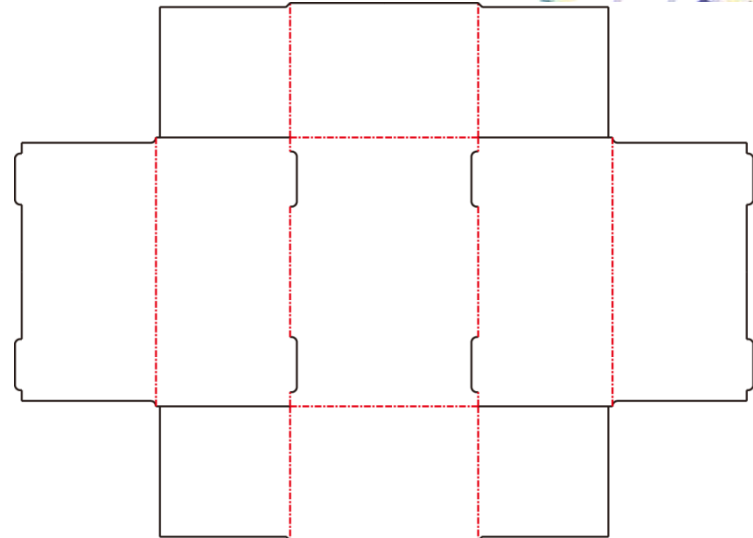
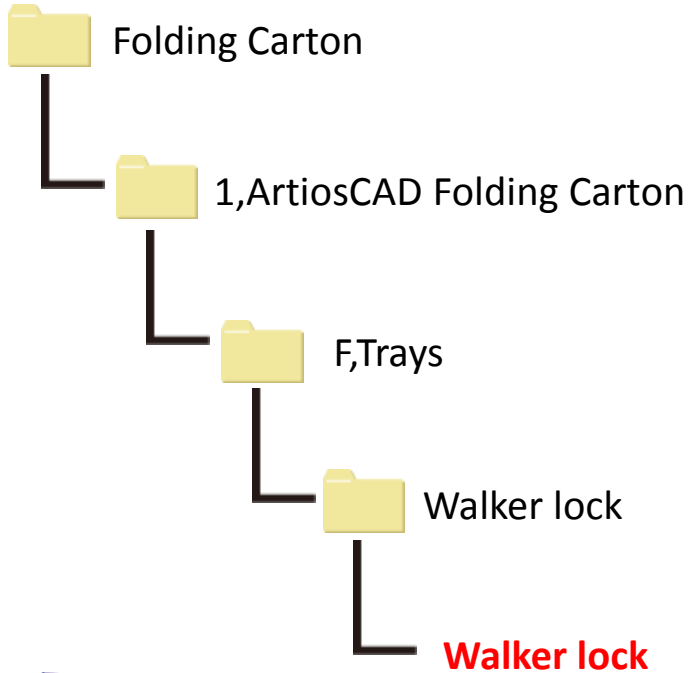

Walker lock

ACDS.8-19

File name

Walker lock 2/tri seal lid

Folding Carton

1,ArtiosCAD Folding Carton

F,Trays

Walker lock

Walker lock 2/tri seal lid

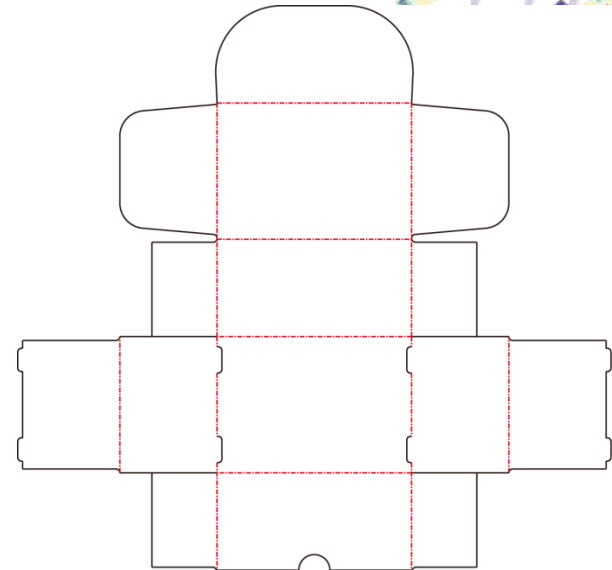

Mimaki™